

**Wooden Storage Cabinet**

**Installation Instructions**

1. This product should only be installed by someone who fully understand the installation instructions.
2. Make sure that the supporting surface will safely support the combined load of the equipment, hardware & components
3. Never exceed the maximum load capacity.
4. Always use assistant or mechanical lifting equipment, if needed, to safely lift & position equipment.
5. Tighten screws firmly, but do not over-tighten. Over-tightening can damage the screw & reduce their holding power
6. This product is intended for indoor use only. Using this product outdoors could lead to product failure & personal injury.

**Component Checklist**

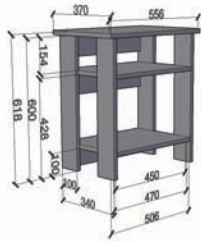

**Installation Steps**

**STEP 1**

**FIX ALL Minifix-Screws and Minifix-Drums:**

**MINIFIX SET**

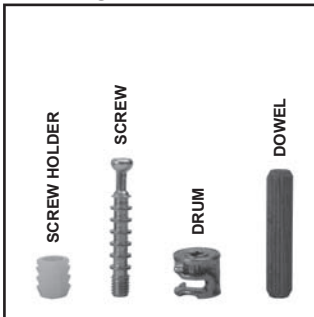

**DRUM INSERTING**

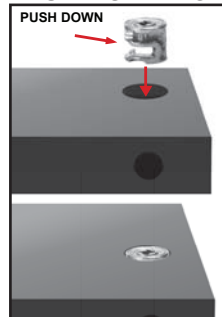

Note: Make sure Drum inserting as same as above, Drum arrow direction at side surface hole side.

**SCREW INSERTING**

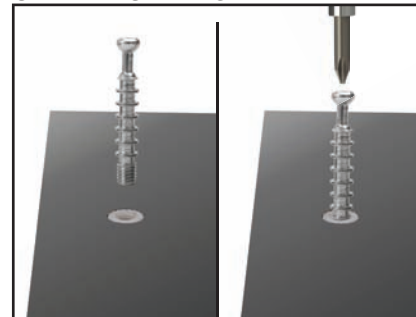

Note: Tight the screw clock-wise till the thread disappear.

**STEP 2**

**Unlock Mode:**

Note: Make sure all the given points otherwise it will not fix properly.

**Minifix-Drum  
Arrow at Hole  
Side Before  
Inserting Minifix-Screw**

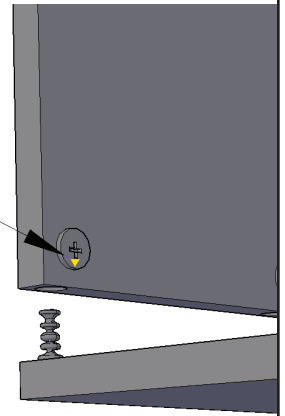

**STEP 3**

**Lock Mode:**

Note: Tight all Minifix-Drums Properly.

**Tighten Minifix-Drum  
Clock-wise  
Till It Stops  
and Fits properly**

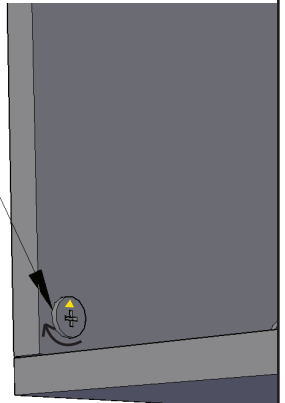

**STEP 4**

**Connect E with B  
and Connect F with C:**

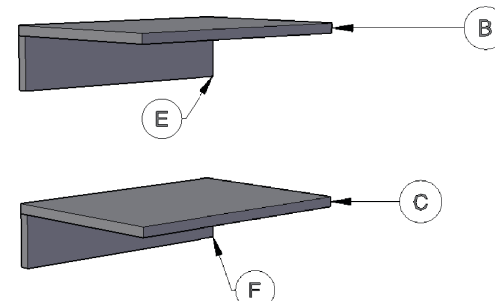

**and Connect G and H with set:**

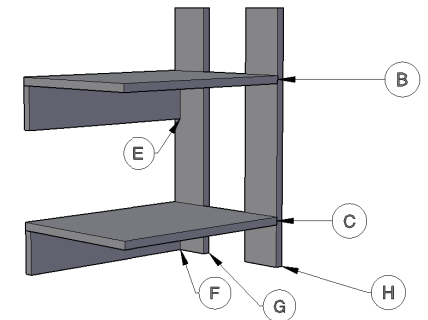

Note: Tight all Minifix-Drums Properly.

STEP 5

**Connect D with Above Set:**

Note: Tight all Minifix-Drums Properly.

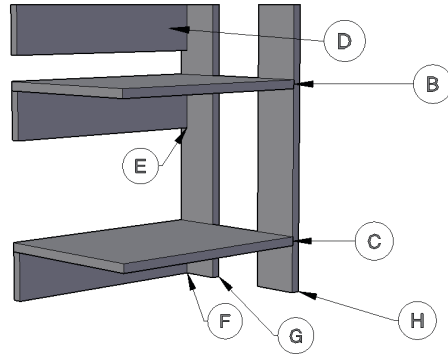

STEP 6

**Connect I & J to Above Set:**

Note: Tight all Minifix-Drums Properly.

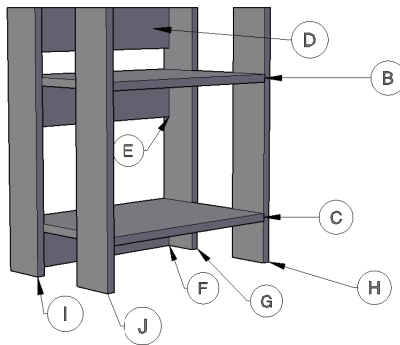

STEP 7

**Connect A to Above Set on TOP and Insert Fabric**

**Drawer:**

Note: Tight all Minifix-Drums Properly.

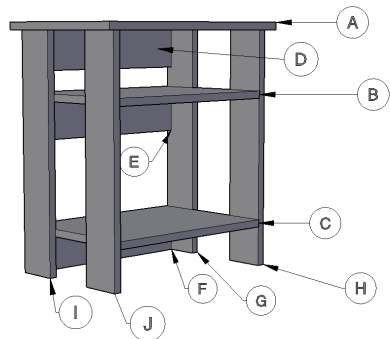

**INSTALLATION GUIDE**

**Wooden Storage Cabinet  
G0250IT0004**

