

TV UNIT - G0223IT0232

Installation Instructions

1. This product should only be installed by someone who fully understand the installation instructions.
2. Make sure that the supporting surface will safely support the combined load of the equipment, hardware & components
3. Never exceed the maximum load capacity.
4. Always use assistant or mechanical lifting equipment, if needed, to safely lift & position equipment.
5. Tighten screws firmly, but do not over-tighten. Over-tightening can damage the screw & reduce their holding power
6. This product is intended for indoor use only. Using this product outdoors could lead to product failure & personal injury.

Component Checklist

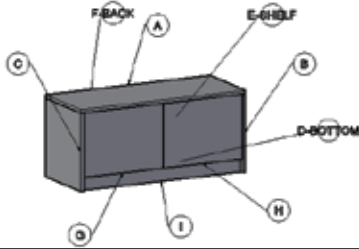

Installation Steps

STEP 1

FIX ALL Minifix-Screws and Minifix-Drums:

MINIFIX SET

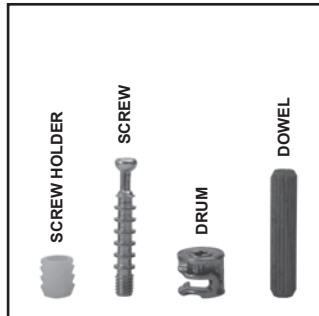

DRUM INSERTING

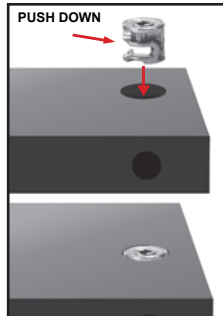

Note: Make sure Drum inserting as same as above, Drum arrow direction at side surface hole side.

SCREW INSERTING

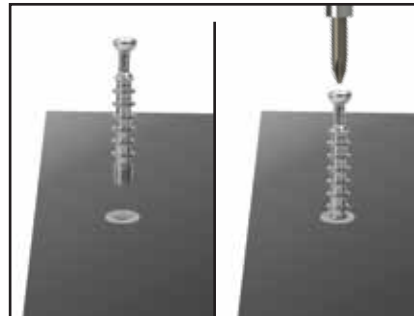

Note: Tight the screw clock-wise till the thread disappear.

STEP 2

Unlock Mode:

Note: Make sure all the given points otherwise it will not fix properly.

**Minifix-Drum
Arrow at Hole
Side Before
Inserting Minifix-Screw**

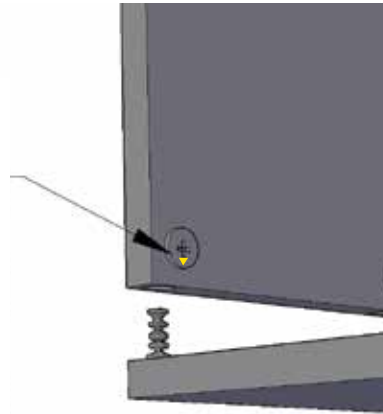

STEP 3

Lock Mode:

Note: Tight all Minifix-Drum Properly.

**Tight Minifix-Drum
Clock-wise
Till It Stops
and Fits properly**

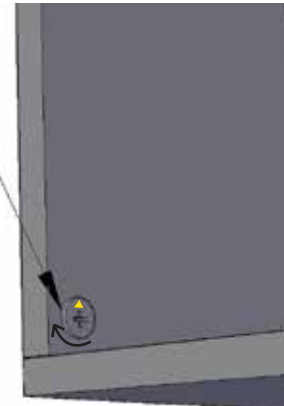

STEP 4

Connect C, B & D With Above Set With I :

Note: Tight all Minifix-Drum Properly.

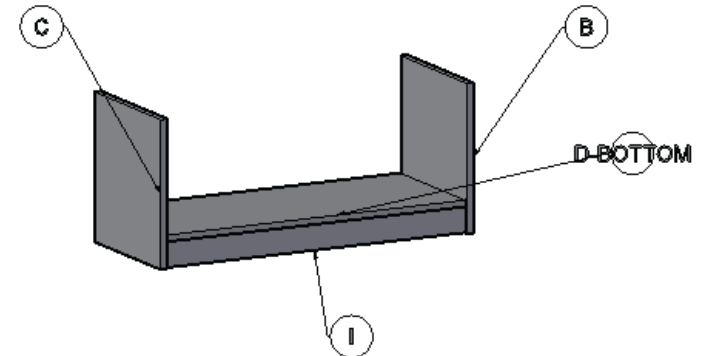

STEP 5

Connect F - Back With C, E, B & D:

Note: Tight all Minifix-Drum Properly.

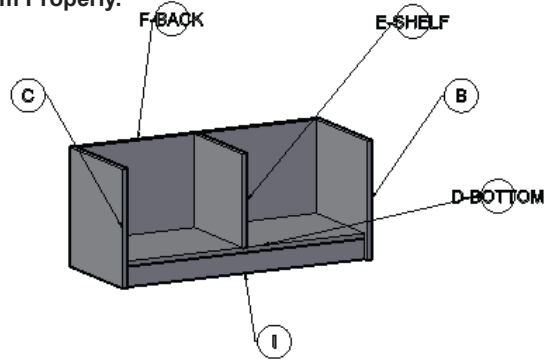

STEP 6

Connect A Set With C, E, B & F:

Note: Tight all Minifix-Drum Properly.

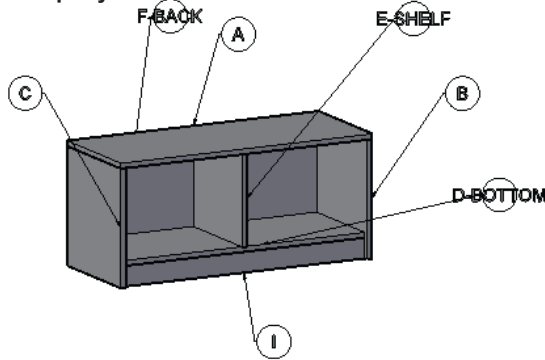

STEP 7

Connect G & H Shutter Set With Above Image:

Note: Tight all Minifix-Drum Properly.

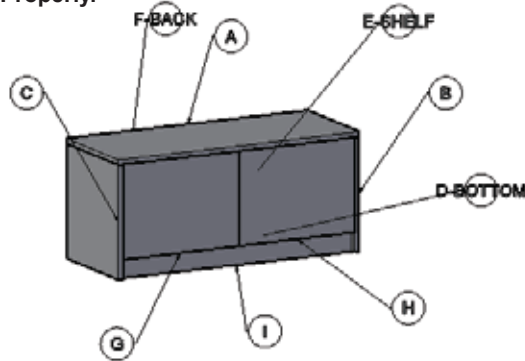

INSTALLATION GUIDE

TV UNIT - G0223IT0232

G0223IT0232

