

## SIDE TABLE

### Installation Instructions

1. This product should only be installed by someone who fully understand the installation instructions.
2. Make sure that the supporting surface will safely support the combined load of the equipment, hardware & components
3. Never exceed the maximum load capacity.
4. Always use assistant or mechanical lifting equipment, if needed, to safely lift & position equipment.
5. Tighten screws firmly, but do not over-tighten. Over-tightening can damage the screw & reduce their holding power
6. This product is intended for indoor use only. Using this product outdoors could lead to product failure & personal injury.

### Component Checklist

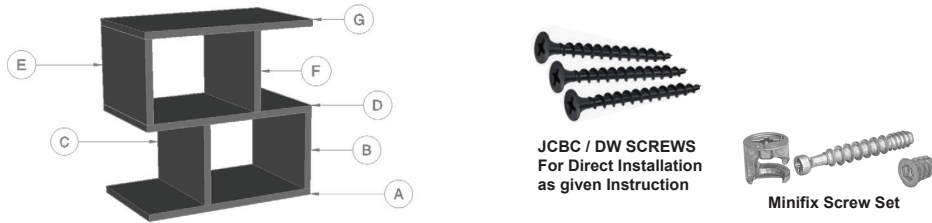

### Installation Steps

#### STEP 1

### FIX ALL Minifix-Screws and Minifix-Drums:

#### MINIFIX SET

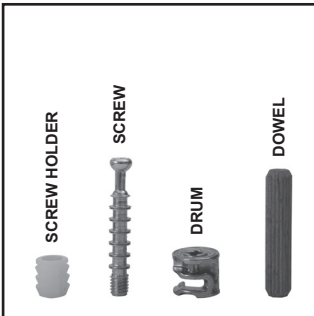

#### DRUM INSERTING

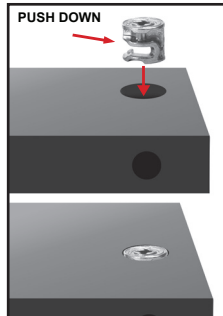

Note: Make sure Drum inserting as same as above, Drum arrow direction at side surface hole side.

#### SCREW INSERTING

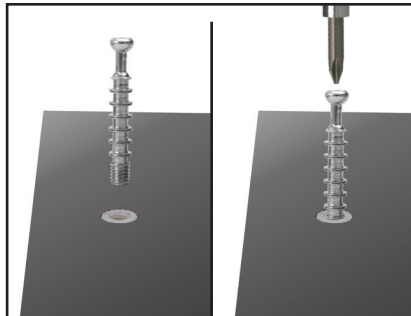

Note: Tight the screw clock-wise till the thread disappear.

#### STEP 2

### Unlock Mode:

Note: Make sure all the given points otherwise it will not fix properly.

## Minifix-Drum Arrow at Hole Side Before Inserting Minifix-Screw

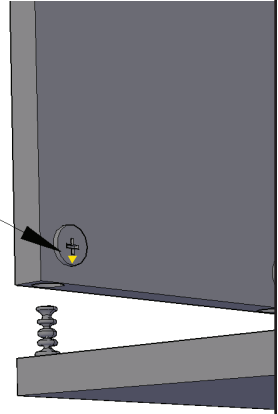

#### STEP 3

### Lock Mode:

Note: Tight all Minifix-Drum Properly.

## Tight Minifix-Drum Clock-wise Till It Stops and Fits properly

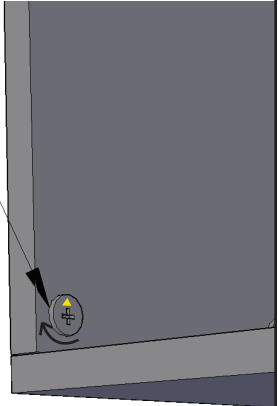

#### STEP 4

### Connect C & B with A:

Note: Tight all Minifix-Drum Properly.

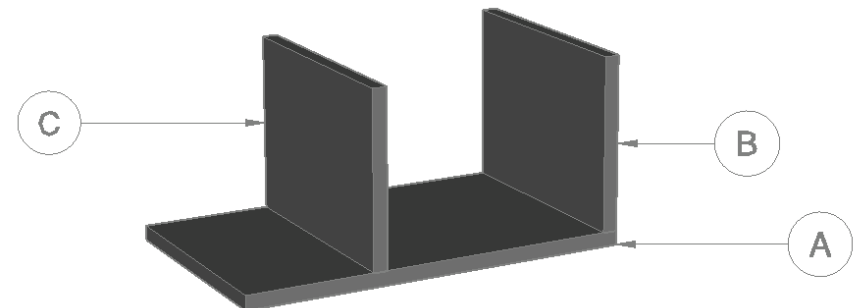

STEP 5

**Connect D to Above Set with C & B:**

Note: Tight all Minifix-Drum Properly.

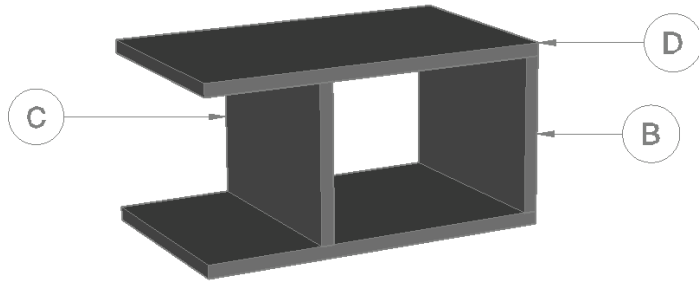

STEP 6

**Connect E & F to Above Set with D:**

Note: Tight all Minifix-Drum Properly.

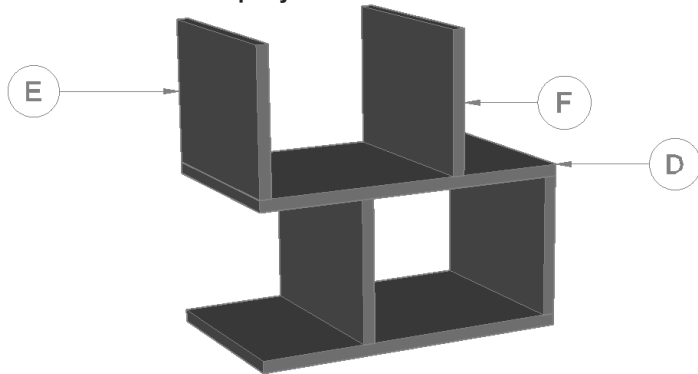

STEP 7

**Connect G to Above Set with E & F:**

Note: Tight all Minifix-Drum Properly.

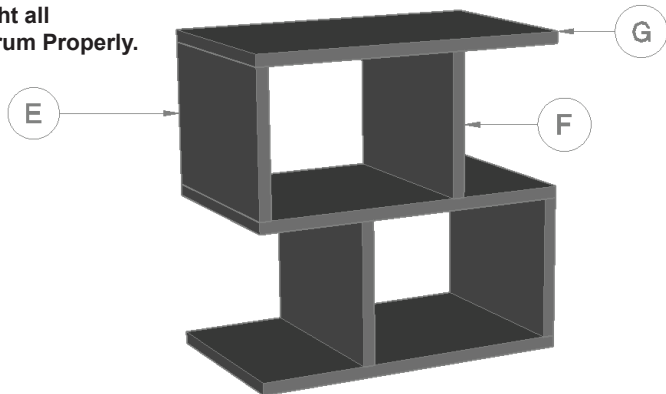

**INSTALLATION GUIDE**

**SIDE TABLE**

**How to Connect Buffers at Bottom Base**

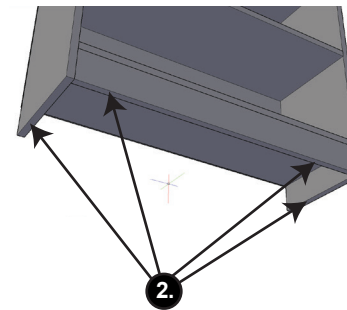

2. Connect Given Buffers at this marks by nails or screws

1. Different types of Buffers

